

Original operating instructions

## **ELC 100** Safety Light Curtain



© 2022

Leuze electronic GmbH + Co. KG

In der Braike 1

73277 Owen / Germany

Phone: +49 7021 573-0

Fax: +49 7021 573-199

[www.leuze.com](http://www.leuze.com)

[info@leuze.com](mailto:info@leuze.com)



<b>1</b>	<b>About this document</b>	<b>5</b>
1.1	Used symbols and signal words	5
1.2	Checklists	6
<b>2</b>	<b>Safety</b>	<b>7</b>
2.1	Intended use and foreseeable misuse	7
2.1.1	Intended use	8
2.1.2	Foreseeable misuse	8
2.2	Necessary competencies	8
2.3	Responsibility for safety	9
2.4	Disclaimer	9
<b>3</b>	<b>Device description</b>	<b>10</b>
3.1	Structure and function	10
3.2	Connection technology	11
3.3	Display elements	12
3.3.1	Operating indicators on the ELC 100 transmitter	12
3.3.2	Operating indicators on the ELC 110 receiver	12
<b>4</b>	<b>Applications</b>	<b>14</b>
4.1	Point of operation guarding	14
<b>5</b>	<b>Mounting</b>	<b>15</b>
5.1	Arrangement of transmitter and receiver	15
5.1.1	Calculation of safety distance S	15
5.1.2	Calculation of safety distance if protective fields act orthogonally to the approach direction	16
5.1.3	Minimum distance to reflective surfaces	20
5.1.4	Preventing mutual interference between adjacent devices	21
5.2	Mounting the safety sensor	22
5.2.1	Suitable mounting locations	22
5.2.2	Fastening via sliding blocks	23
5.2.3	Fastening via BT-2SB05 swiveling mounting brackets	23
<b>6</b>	<b>Electrical connection</b>	<b>24</b>
6.1	Pin assignment transmitter and receiver	25
6.1.1	ELC 100 transmitter	25
6.1.2	ELC 110 receiver	25
6.1.3	Circuit diagram example	26
<b>7</b>	<b>Starting up the device</b>	<b>27</b>
7.1	Switching on	27
7.2	Aligning the sensor	28
<b>8</b>	<b>Testing</b>	<b>29</b>
8.1	Before commissioning and following modifications	29
8.1.1	Checklist for integrator – to be performed prior to commissioning and following modifications	29
8.2	To be performed periodically by competent persons	31
8.3	Periodically by the operator	31
8.3.1	Checklist – periodically by the operator	32
<b>9</b>	<b>Care, maintenance and disposal</b>	<b>33</b>

<b>10</b>	<b>Diagnostics and troubleshooting</b> .....	<b>34</b>
10.1	What to do in case of failure? .....	34
10.2	Operating indicators of the LEDs .....	34
<b>11</b>	<b>Service and support</b> .....	<b>35</b>
<b>12</b>	<b>Technical data</b> .....	<b>36</b>
12.1	General specifications .....	36
12.2	Dimensions, weight, response time .....	39
12.3	Dimensioned drawings: Accessories .....	40
<b>13</b>	<b>Order guide and accessories</b> .....	<b>41</b>
13.1	Part number code .....	41
13.2	Type overview .....	41
13.3	Accessories .....	42
<b>14</b>	<b>EC Declaration of Conformity</b> .....	<b>43</b>



## 1 About this document

### 1.1 Used symbols and signal words

Tab. 1.1: Warning symbols and signal words

	Symbol indicating dangers to persons
	Symbol indicating possible property damage
<b>NOTE</b>	Signal word for property damage Indicates dangers that may result in property damage if the measures for danger avoidance are not followed.
<b>CAUTION</b>	Signal word for minor injuries Indicates dangers that may result in minor injury if the measures for danger avoidance are not followed.
<b>WARNING</b>	Signal word for serious injury Indicates dangers that may result in severe or fatal injury if the measures for danger avoidance are not followed.
<b>DANGER</b>	Signal word for life-threatening danger Indicates dangers with which serious or fatal injury is imminent if the measures for danger avoidance are not followed.

Tab. 1.2: Other symbols

	Symbol for tips Text passages with this symbol provide you with further information.
	Symbol for action steps Text passages with this symbol instruct you to perform actions.
	Symbol for action results Text passages with this symbol describe the result of the preceding action.

Tab. 1.3: Terms and abbreviations

Response time	The response time of the protective device is the maximum time between the occurrence of the event that results in activation of the safety sensor and the provision of the switching signal at the interface of the protective device (e.g., OFF state of the OSSD pair).
AOPD	Active Optoelectronic Protective Device ( <b>A</b> ctive <b>O</b> ptoelectronic <b>P</b> rotective <b>D</b> evice)
ESPE	<b>E</b> lectro-sensitive protective equipment
ELC	Brief description of the safety sensor, consisting of transmitter and receiver
LED	LED, display element in transmitter and receiver
MTTF <sub>d</sub>	Mean time to dangerous failure ( <b>M</b> ean <b>T</b> ime <b>T</b> o dangerous <b>F</b> ailure)
OSSD	Safety-related switching output ( <b>O</b> utput <b>S</b> ignal <b>S</b> witching <b>D</b> evice)
PFH <sub>d</sub>	Probability of a dangerous failure per hour ( <b>P</b> robability of dangerous <b>F</b> ailure per <b>H</b> our)
PL	<b>P</b> erformance <b>L</b> evel
Safety sensor	System consisting of transmitter and receiver
SIL	<b>S</b> afety <b>I</b> ntegrity <b>L</b> evel
State	ON: device intact, OSSD switched on OFF: device intact, OSSD switched off Locking: device, connection or control / operation faulty, OSSD switched off (lock-out)

## 1.2 Checklists

The checklists (see chapter 8 "Testing") serve as a reference for the machine manufacturer or supplier. They replace neither testing of the complete machine or system prior to initial commissioning nor their periodic testing by a qualified person (Necessary competencies). The checklists contain minimum testing requirements. Depending on the application, other tests may be necessary.

## 2 Safety

Before using the safety sensor, a risk assessment must be performed according to valid standards (e.g. ISO/EN ISO 12100, ISO/EN ISO 13849-1, IEC/EN 61508, IEC/EN 62061). The result of the risk assessment determines the required safety level of the safety sensor (Safety-relevant technical data). For mounting, operating and testing, this document as well as all applicable national and international standards, regulations, rules and directives must be observed. Relevant and supplied documents must be observed, printed out and handed to affected persons.



↳ Before working with the safety sensor, completely read and observe the documents applicable to your task.

In particular, the following national and international legal regulations apply for the commissioning, technical inspections and work with safety sensors:

- Machinery directive 2006/42/EC
- Low voltage directive 2014/35/EU
- EMC directive 2014/30/EU
- OSHA 1910 Subpart O
- Safety regulations
- Accident-prevention regulations and safety rules
- Ordinance on Industrial Safety and Health and employment protection act
- Product Safety Law (ProdSG)

<b>NOTICE</b>	
	<p>For safety-related information you may also contact local authorities (e.g., industrial inspectorate, employer's liability insurance association, labor inspectorate, occupational safety and health authority).</p>

### 2.1 Intended use and foreseeable misuse

 <b>WARNING</b>	
	<p><b>A running machine may result in serious injury!</b></p> <p>↳ Make certain that the safety sensor is correctly connected and that the protective function of the protective device is ensured.</p> <p>↳ Make certain that, during all conversions, maintenance work and inspections, the system is securely shut down and protected against being restarted.</p>

### 2.1.1 Intended use

- The safety sensor may only be used after it has been selected in accordance with the respectively applicable instructions and relevant standards, rules and regulations regarding labor protection and safety at work, and after it has been installed on the machine, connected, commissioned, and checked by a competent person (Necessary competencies). The devices are designed for indoor use only.
- When selecting the safety sensor it must be ensured that its safety-related capability meets or exceeds the required performance level  $PL_r$ , ascertained in the risk assessment (see chapter 12.1 "General specifications").
- The safety sensor protects persons or body parts at points of operation, danger zones or access points of machines and systems.
- With the *access guarding* function, the safety sensor detects persons only when they enter the danger zone but cannot tell whether there are any persons inside the danger zone. For this reason, a start/restart interlock or a suitable stepping behind protection in the safety chain is essential in this case.
- Maximum permissible approach speeds (see ISO/EN ISO 13855):
  - 1.6 m/s for access guarding
  - 2.0 m/s for guards of points of operation
- The construction of the safety sensor must not be altered. When manipulating the safety sensor, the protective function is no longer guaranteed. Manipulating the safety sensor also voids all warranty claims against the manufacturer of the safety sensor.
- The improper repair of the protective device may result in loss of the protective function. Make no repairs to the device components.
- The safety sensor must be inspected regularly by a competent person to ensure proper integration and mounting (Necessary competencies).
- The safety sensor must be exchanged after a maximum of 20 years. Repairs or the exchange of wear parts do not extend the mission time.

### 2.1.2 Foreseeable misuse

Any use other than that defined under the "Approved purpose" or which goes beyond that use is considered improper use.

In principle, the safety sensor is **not** suitable as a protective device for use in the following cases:

- Danger posed by ejected objects or the spraying of hot or hazardous liquids from within the danger zone
- Applications in explosive or easily flammable atmospheres
- Applications outdoors or submerged in water or other liquids

## 2.2 Necessary competencies

The safety sensor may only be configured, installed, connected, commissioned, serviced and tested in its respective application by persons who are suitably qualified for the given task. General prerequisites for suitably qualified persons:

- They have a suitable technical education.
- They are familiar with the relevant parts of the operating instructions for the safety sensor and the operating instructions for the machine.

Task-specific minimum requirements for competent persons:

### Configuration

Specialist knowledge and experience in the selection and use of protective devices on machines as well as the application of technical rules and the locally valid regulations on labor protection, safety at work and safety technology.

Specialist knowledge in programming safety-related controls SRASW acc. to ISO/EN ISO 13849-1.

### Mounting

Specialist knowledge and experience needed for the safe and correct installation and alignment of the safety sensor with regard to the respective machine.

**Electrical installation**

Specialist knowledge and experience needed for the safe and correct electrical connection as well as safe integration of the safety sensor in the safety-related control system.

**Operation and maintenance**

Specialist knowledge and experience needed for the regular inspection and cleaning of the safety sensor – following instruction by the person responsible.

**Servicing**

Specialist knowledge and experience in the mounting, electrical installation and the operation and maintenance of the safety sensor in accordance with the requirements listed above.

**Commissioning and testing**

- Experience and specialist knowledge in the rules and regulations of labor protection, safety at work and safety technology that are necessary for being able to assess the safety of the machine and the use of the safety sensor, including experience with and knowledge of the measuring equipment necessary for performing this work.
- In addition, a task related to the subject matter is performed in a timely manner and knowledge is kept up to date through continuous further training - *Competent person* in terms of the German Betriebs-sicherheitsverordnung (Ordinance on Industrial Safety and Health) or other national legal regulations.

**2.3 Responsibility for safety**

Manufacturer and operator must ensure that the machine and implemented safety sensor function properly and that all affected persons are adequately informed and trained.

The type and content of all imparted information must not lead to unsafe actions by users.

The manufacturer of the machine is responsible for:

- Safe machine construction and information on any residual risks
- Safe implementation of the safety sensor, verified by the initial test performed by a competent person
- Imparting all relevant information to the operating company
- Adhering to all regulations and directives for the safe commissioning of the machine

The operator of the machine is responsible for:

- Instructing the operator
- Maintaining the safe operation of the machine
- Adhering to all regulations and directives for labor protection and safety at work
- Regular testing by competent persons

**2.4 Disclaimer**

Leuze electronic GmbH + Co. KG is not liable in the following cases:

- The safety sensor is not used as intended.
- Safety notices are not adhered to.
- Reasonably foreseeable misuse is not taken into account.
- Mounting and electrical connection are not properly performed.
- Proper function is not tested (see chapter 8 "Testing").
- Changes (e.g., constructional) are made to the safety sensor.

### 3 Device description

The safety sensors from the ELC 100 series are active optoelectronic protective devices. They satisfy the following standards:

	ELC 100
Type in accordance with IEC/EN IEC 61496	4
Category in acc. with ISO/EN ISO 13849-1:2015	4
Performance Level (PL) in accordance with ISO/EN ISO 13849-1:2015	e
Safety Integrity Level (SIL) in accordance with IEC/EN 61508 or SILCL in accordance with IEC/EN 62061	3

The safety sensor consists of a transmitter and a receiver. It is protected against overvoltage and overcurrent acc. to IEC/EN 60204-1 (protection class 3). The safety sensor is not dangerously influenced by typical ambient light.

#### 3.1 Structure and function

The ELC 100 safety light curtain is a piece of electro-sensitive protective equipment (ESPE) that consists of a transmitter and a receiver.

A series of parallel infrared light beams creates a protective field between transmitter and receiver that safeguards the danger zone (point of operation, access point and danger zone safeguarding). As soon as one or more beams are completely interrupted, the safety light curtain reports the interruption of the light path by means of a signal change at the safe switching outputs (OSSDs). The machine or its control must safely evaluate the signals (e.g. with a safe control or a safety relay) and end the dangerous state.

Transmitter and receiver automatically synchronize themselves using optical means. An electrical connection between the two components is not necessary.

#### Protective field properties

The beam distance and the number of beams are dependent on the resolution and protective field height.

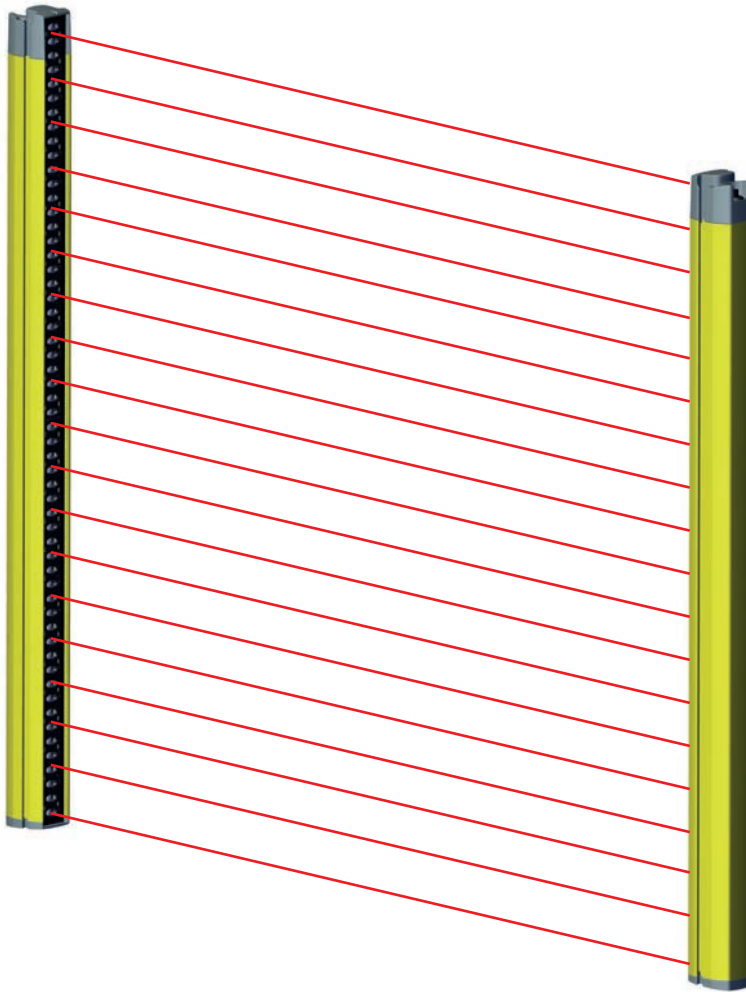

Fig. 3.1: ELC transmitter/receiver

**Absence of dead zones**

Due to the design and construction of the safety light curtain, the protective function of a device is free of dead zones up to the end of the housing.

The absence of dead zones reduces space requirements when integrating in the machine.

**3.2 Connection technology**

The transmitter and receiver feature an M12 connector as an interface to the machine control with the following number of pins:

Device model	Device type	Device plug
ELC 100	Transmitter	4-pin
ELC 110	Receiver	4-pin

### 3.3 Display elements

The display elements of the safety sensors simplify start-up and fault analysis.

#### 3.3.1 Operating indicators on the ELC 100 transmitter

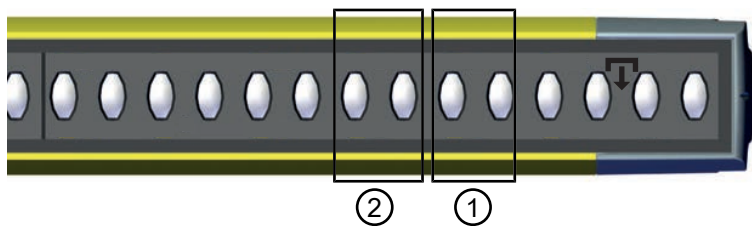

- 1 LED pair 1, red
- 2 LED pair 2, green

Fig. 3.2: Indicators on the ELC 100 transmitter

Tab. 3.1: Meaning of the LEDs on the transmitter

LED	Color	State	Description
1	Red	Flashing	Error
		Flash sequence 2x ON/OFF (250 ms), followed by a pause (750 ms)	Connection error
		Rapid flashing (10 Hz)	Device error
2	Green	OFF	Device switched off
		ON	Transmitter switched on

#### 3.3.2 Operating indicators on the ELC 110 receiver

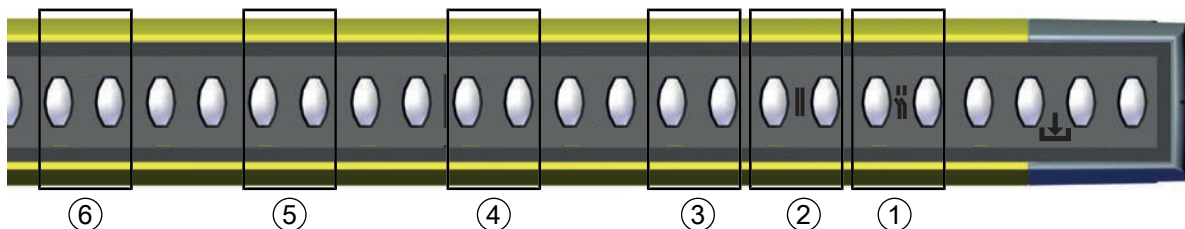

- 1 LED pair 1, red, open OSSD icon
- 2 LED pair 2, green, closed OSSD icon
- 3 LED 3, blue
- 4 LED 4, blue
- 5 LED 5, blue
- 6 LED 6, blue

Fig. 3.3: Indicators on the ELC 110 receiver

Tab. 3.2: Meaning of the LEDs on the receiver

LED	Color	State	Description
1	Red	ON	OSSD off
		Slow flashing (approx. 0.5 Hz)	External error
		Rapid flashing (approx. 10 Hz)	Internal error
		Flash sequence 2x ON/OFF (250 ms), followed by a pause (750 ms)	Connection error
2	Green	ON	OSSD on
3	Blue	Flashes	Light reception strength 1
		ON	Light reception strength 2
4	Blue	Flashes	Light reception strength 3
		ON	Light reception strength 4, OSSD switches on
5	Blue	Flashes	Light reception strength 5
		ON	Light reception strength 6
6	Blue	Flashes	Light reception strength 7
		ON	Light reception strength 8, optimum alignment
		Flashes brightly	Fault in light reception

## 4 Applications

The safety sensor only creates square protective fields.

### 4.1 Point of operation guarding

Point of operation guarding for hand and finger protection is typically the most common application for this safety sensor. The necessary safety distance, among other things, follows from the various resolutions (see chapter 5.1.1 "Calculation of safety distance S").

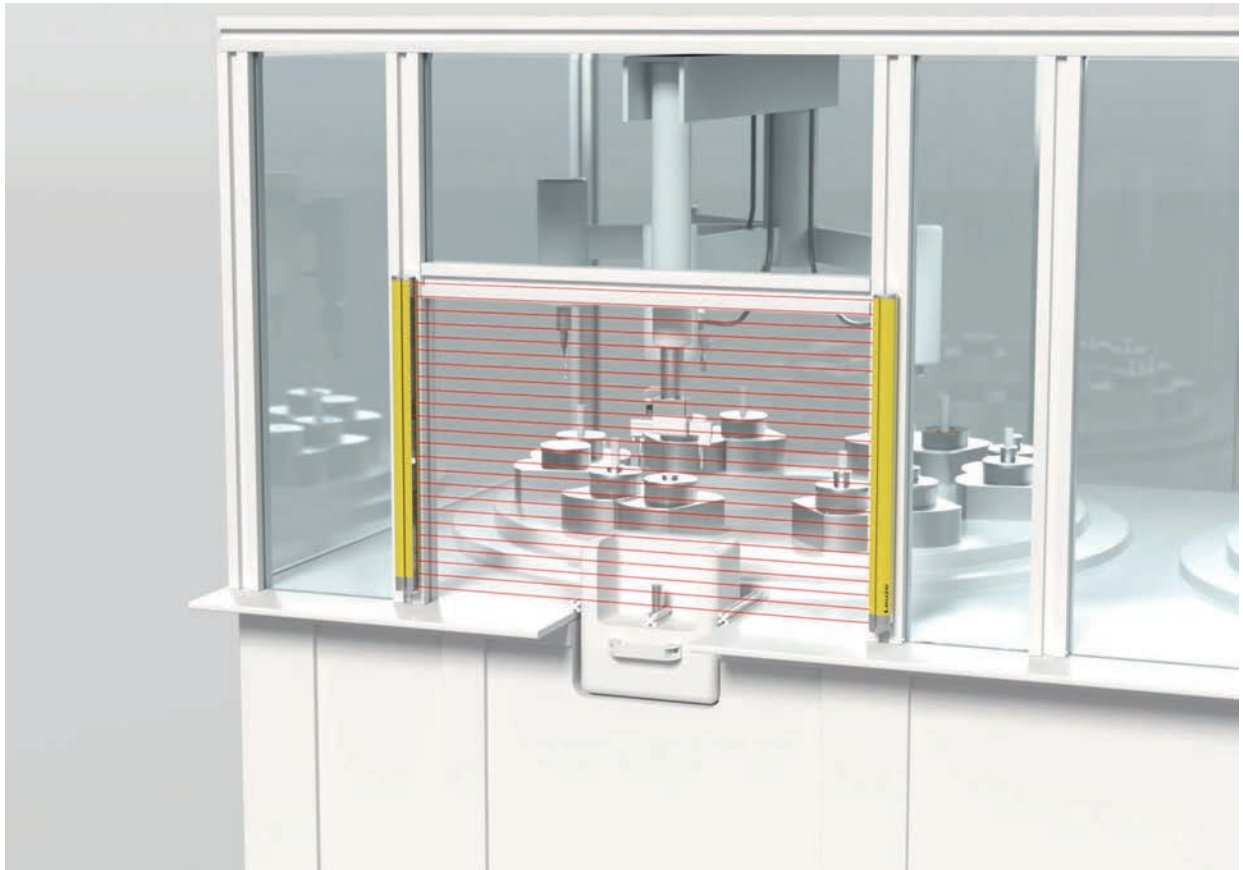



Fig. 4.1: Point of operation guarding

## 5 Mounting

 <b>WARNING</b>	
	<p><b>Improper mounting may result in serious injury!</b></p> <p>The protective function of the safety sensor is only ensured if appropriately and professionally mounted for the respective, intended area of application.</p> <ul style="list-style-type: none"> <li>↳ Only allow the safety sensor to be installed by qualified persons (Necessary competencies).</li> <li>↳ Maintain the necessary safety distances (see chapter 5.1.1 "Calculation of safety distance S").</li> <li>↳ Make sure that stepping behind, crawling under or stepping over the protective device is reliably ruled out and reaching under, over or around is taken into account in the safety distance, if applicable with additional distance <math>C_{RO}</math> corresponding to ISO/EN ISO 13855.</li> <li>↳ Take measures to prevent that the safety sensor can be used to gain access to the danger zone, e.g. by stepping or climbing into it.</li> <li>↳ Observe the relevant standards, regulations and these instructions.</li> <li>↳ Clean the transmitter and receiver at regular intervals: environmental conditions (see chapter 12 "Technical data"), care (see chapter 9 "Care, maintenance and disposal").</li> <li>↳ After mounting, check the safety sensor for proper function.</li> </ul>

### 5.1 Arrangement of transmitter and receiver

Optical protective devices can only perform their protective function if they are mounted with adequate safety distance. When mounting, all delay times must be taken into account, such as the response times of the safety sensor and control elements as well as the stopping time of the machine, among others.

The following standard specifies calculation formulas:

- ISO/EN ISO 13855, "Safety of machines - The positioning of protective equipment in respect of approach speeds of parts of the human body": mounting situation and safety distances

<b>NOTICE</b>	
	<p>In accordance with ISO/EN ISO 13855, with a vertical protective field, it is possible to pass under beams over 300 mm or pass over beams under 900 mm. If the protective field is horizontal, climbing on the safety sensor must be prevented through suitable installation or with covers and the like.</p>

#### 5.1.1 Calculation of safety distance S

General formula for calculating the safety distance S of an Optoelectronic Protective Device acc. to ISO/EN ISO 13855

$$S = K \cdot T + C$$

S	[mm]	=	Safety distance
K	[mm/s]	=	Approach speed
T	[s]	=	Total time of the delay, sum from ( $t_a + t_i + t_m$ )
$t_a$	[s]	=	Response time of the protective device
$t_i$	[s]	=	Response time of the safety relay
$t_m$	[s]	=	Stopping time of the machine
C	[mm]	=	Additional distance to the safety distance

<b>NOTICE</b>	
	<p>If longer stopping times are determined during regular inspections, an appropriate additional time must be added to <math>t_m</math>.</p>

5.1.2 Calculation of safety distance if protective fields act orthogonally to the approach direction

With vertical protective fields, ISO/EN ISO 13855 differentiates between

- S<sub>RT</sub>: safety distance concerning access **through** the protective field
- S<sub>RO</sub>: safety distance concerning access **over** the protective field

The two values are distinguished by the way additional distance C is determined:

- C<sub>RT</sub>: from a calculation formula or as a constant (see chapter 5.1.1 "Calculation of safety distance S")
- C<sub>RO</sub>: from the following table "Reaching over the vertical protective field of electro-sensitive protective equipment (excerpt from ISO/EN ISO 13855)"

The larger of the two values S<sub>RT</sub> and S<sub>RO</sub> is to be used.

Calculation of safety distance S<sub>RT</sub> acc. to ISO/EN ISO 13855 when access occurs through the protective field:

Calculation of safety distance S<sub>RT</sub> for point of operation guarding

$$S_{RT} = K \cdot T + C_{RT}$$

S <sub>RT</sub>	[mm]	=	Safety distance
K	[mm/s]	=	Approach speed for point of operation guarding with approach reaction and normal approach direction to the protective field (resolution 14 to 40 mm): 2000 mm/s or 1600 mm/s, when S <sub>RT</sub> > 500 mm
T	[s]	=	Total time of the delay, sum from (t <sub>a</sub> + t <sub>i</sub> + t <sub>m</sub> )
t <sub>a</sub>	[s]	=	Response time of the protective device
t <sub>i</sub>	[s]	=	Response time of the safety relay
t <sub>m</sub>	[s]	=	Stopping time of the machine
C <sub>RT</sub>	[mm]	=	Additional distance for point of operation guarding with approach reaction with resolutions of 14 to 40 mm, d = resolution of protective device C <sub>RT</sub> = 8 × (d - 14) mm

Calculation example

The feeding-in area in a press with a stopping time (including press Safety PLC) of 190 ms is to be safeguarded with a safety light curtain with 17 mm of resolution and 1200 mm of protective field height. The safety light curtain has a response time of 17 ms.

↳ Calculate safety distance S<sub>RT</sub> using the formula acc. to ISO/EN ISO 13855.

$$S_{RT} = K \cdot T + C_{RT}$$

K	[mm/s]	=	2000
T	[s]	=	(0.017 + 0.190)
C <sub>RT</sub>	[mm]	=	8 × (17 - 14)
S <sub>RT</sub>	[mm]	=	2000 mm/s × 0.207 s + 24 mm
<b>S<sub>RT</sub></b>	<b>[mm]</b>	=	<b>438</b>

S<sub>RT</sub> is smaller than 500 mm; this is why the calculation may **not** be repeated with 1600 mm/s.

<b>NOTICE</b>	
	Implement the stepping behind protection required here, e.g. through the use of an additional safety sensor.

Calculation of safety distance  $S_{RO}$  acc. to ISO/EN ISO 13855 when protective field is accessed from above:

Calculation of safety distance  $S_{RO}$  for point of operation guarding

$$S_{RO} = K \cdot T + C_{RO}$$

$S_{RO}$	[mm]	= Safety distance
$K$	[mm/s]	= Approach speed for point of operation guarding with approach reaction and normal approach direction to the protective field (resolution 14 to 40 mm): 2000 mm/s or 1600 mm/s, when $S_{RO} > 500$ mm
$T$	[s]	= Total time of the delay, sum from ( $t_a + t_i + t_m$ )
$t_a$	[s]	= Response time of the protective device
$t_i$	[s]	= Response time of the safety relay
$t_m$	[s]	= Stopping time of the machine
$C_{RO}$	[mm]	= Additional distance in which a body part can move towards the protective device before the protective device triggers: value (see the following table "Reaching over the vertical protective field of electro-sensitive protective equipment (excerpt from ISO/EN ISO 13855)").

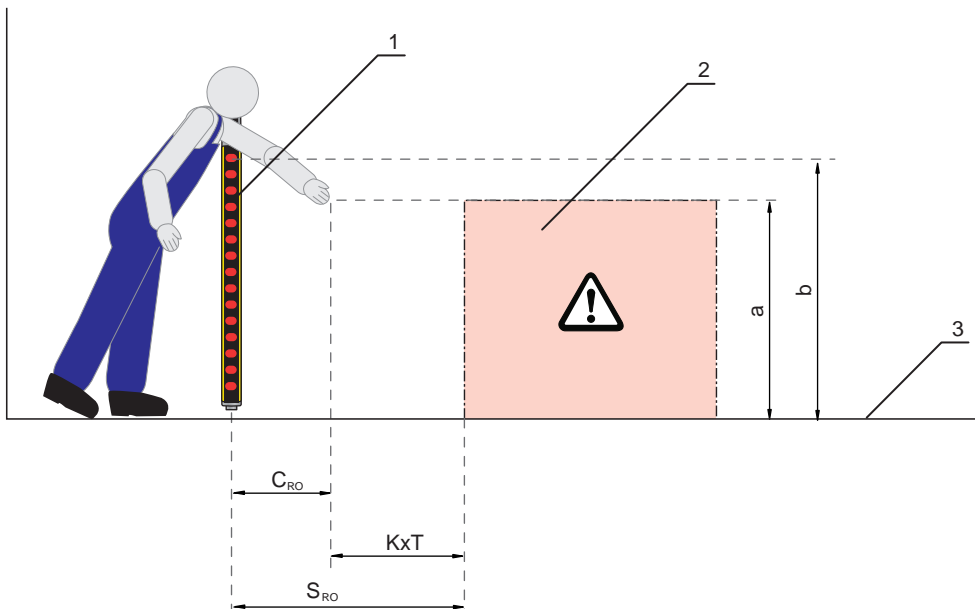

- 1 Safety sensor
- 2 Danger zone
- 3 Floor
- a Height of the point of operation
- b Height of the upper beam of the safety sensor

Fig. 5.1: Additional distance to the safety distance in the case of reaching over

Tab. 5.1: Reaching over the vertical protective field of electro-sensitive protective equipment(excerpt from ISO/ EN ISO 13855)

Height a of the point of operation [mm]	Height b of the upper edge of the protective field of the electro-sensitive protective equipment											
	900	1000	1100	1200	1300	1400	1600	1800	2000	2200	2400	2600
	Additional distance $C_{RO}$ to the danger zone [mm]											
2600	0	0	0	0	0	0	0	0	0	0	0	0
2500	400	400	350	300	300	300	300	300	250	150	100	0
2400	550	550	550	500	450	450	400	400	300	250	100	0
2200	800	750	750	700	650	650	600	550	400	250	0	0
2000	950	950	850	850	800	750	700	550	400	0	0	0
1800	1100	1100	950	950	850	800	750	550	0	0	0	0
1600	1150	1150	1100	1000	900	850	750	450	0	0	0	0
1400	1200	1200	1100	1000	900	850	650	0	0	0	0	0
1200	1200	1200	1100	1000	850	800	0	0	0	0	0	0
1000	1200	1150	1050	950	750	700	0	0	0	0	0	0
800	1150	1050	950	800	500	450	0	0	0	0	0	0
600	1050	950	750	550	0	0	0	0	0	0	0	0
400	900	700	0	0	0	0	0	0	0	0	0	0
200	600	0	0	0	0	0	0	0	0	0	0	0
0	0	0	0	0	0	0	0	0	0	0	0	0

Depending on the specified values you can work with the above-mentioned table in three ways:

1. Given are:

- Height a of the point of operation
- Distance S of the point of operation from the safety sensor, and additional distance  $C_{RO}$

To be determined is the required height b of the upper beam of the safety sensor and thereby its protective field height.

- ↪ Look for the line with the specification of the point of operation height in the left column.
- ↪ In this line, look for the column with the next highest specification for additional distance  $C_{RO}$ .
- ⇒ The required height of the upper beam of the safety sensor is up top in the column head.

2. Given are:

- Height a of the point of operation
- Height b of the upper beam of the safety sensor

To be determined is the required distance S of the safety sensor to the point of operation and thereby additional distance  $C_{RO}$ .

- ↪ In the column head, look for the column with the next lowest entry for the height of the upper beam of the safety sensor.
- ↪ Look for the line with the next highest specification of the point of operation height a in this column.
- ⇒ In the intersection point of the line and the column, you will find additional distance  $C_{RO}$ .

3. Given are:

- Distance S of the point of operation from the safety sensor, and additional distance  $C_{RO}$ .
- Height b of the upper beam of the safety sensor

To be determined is the permitted height  $a$  of the point of operation.

- ↳ In the column head, look for the column with the next lowest entry for the height of the upper beam of the safety sensor.
- ↳ Look for the next lowest value for real additional distance  $C_{RO}$  in this column.
- ⇒ In this line, go to the left column: here you will find the permitted height of the point of operation.
- ↳ Now calculate safety distance  $S$  using the general formula acc. to ISO/EN ISO 13855 (see chapter 5.1.1 "Calculation of safety distance  $S$ ").
- ⇒ The larger of the two values  $S_{RT}$  and  $S_{RO}$  is to be used.

**Calculation example**

The feeding-in area in a press with a stopping time of 130 ms is to be safeguarded with a safety light curtain with 17 mm of resolution and 600 mm of protective field height. The response time of the safety light curtain is 9.5 ms; the press Safety PLC has a response time of 40 ms.

The safety sensor can be reached over. The upper edge of the protective field is located at a height of 1400 mm; the point of operation is located at a height of 1000 mm

Additional distance  $C_{RO}$  to the point of operation is 700 mm (see table "Reaching over the vertical protective field of electro-sensitive protective equipment (excerpt from ISO/EN ISO 13855)").

- ↳ Calculate safety distance  $S_{RO}$  using the formula acc. to ISO/EN ISO 13855.

$$S_{RO} = K \cdot T + C_{RO}$$

K	[mm/s]	=	2000
T	[s]	=	(0.0095 + 0.040 + 0.130)
$C_{RO}$	[mm]	=	700
$S_{RO}$	[mm]	=	2000 mm/s × 0.17915 s + 700 mm
<b><math>S_{RO}</math></b>	<b>[mm]</b>	=	<b>1058</b>

$S_{RO}$  is larger than 500 mm; this is why the calculation may be repeated with approach speed 1600 mm/s:

$$S_{RO} = K \cdot T + C_{RO}$$

K	[mm/s]	=	1600
T	[s]	=	(0.0095 + 0.040 + 0.130)
$C_{RO}$	[mm]	=	700
$S_{RO}$	[mm]	=	1600 mm/s × 0.17915 s + 700 mm
<b><math>S_{RO}</math></b>	<b>[mm]</b>	=	<b>987</b>

**NOTICE**



Depending on the machine construction, stepping behind protection, e.g. using a second horizontally arranged safety light curtain, is necessary.

5.1.3 Minimum distance to reflective surfaces

**WARNING**

**Failure to maintain minimum distances to reflective surfaces may result in serious injury!**

Reflective surfaces can indirectly deflect the transmitter beams to the receiver. In this case, interruption of the protective field is not detected.

- ↪ Determine the minimum distance a (see figure below).
- ↪ Make certain that all reflective surfaces are the necessary minimum distance away from the protective field according to IEC/EN IEC 61496-2 (see the following diagram “Minimum distance to reflective surfaces as a function of the protective field width”).
- ↪ Check that reflective surfaces do not impair the detection capability of the safety sensor before start-up and at appropriate intervals.
- ↪ After mounting, check the detection capability of the safety sensor in the entire protective field using a test rod (see chapter 8.3.1 "Checklist – periodically by the operator").

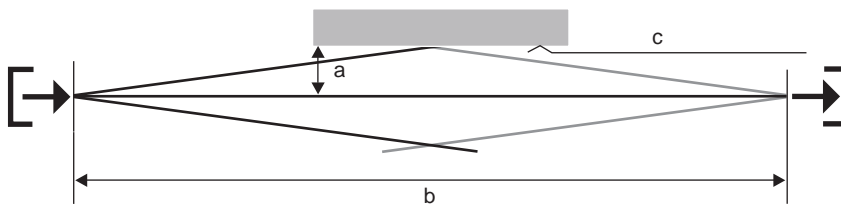

- a Required minimum distance to reflective surfaces [mm]
- b Protective field width [m]
- c Reflective surface

Fig. 5.2: Minimum distance to reflective surfaces depending on protective field width

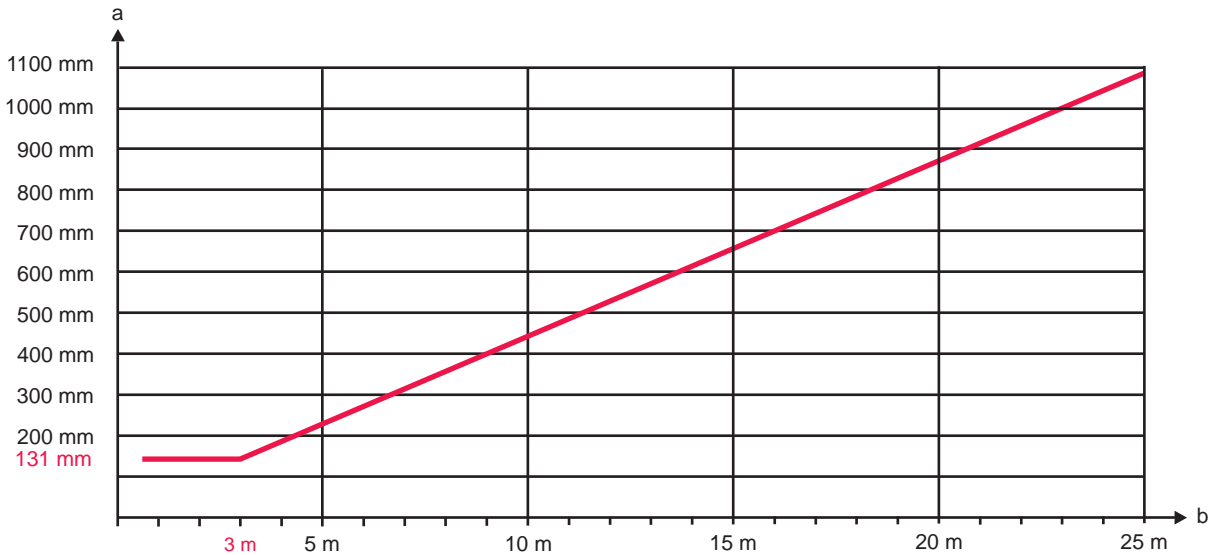

- a Required minimum distance to reflective surfaces [mm]
- b Protective field width [m]

Fig. 5.3: Minimum distance to reflective surfaces as a function of the protective field width

Tab. 5.2: Formula for calculating the minimum distance to reflective surfaces

Distance (b) transmitter-receiver	Calculation of the minimum distance (a) to reflective surfaces
$b \leq 3$ m	$a$ [mm] = 131
$b > 3$ m	$a$ [mm] = $\tan(2.5^\circ) \times 1000 \times b$ [m] = $43.66 \times b$ [m]

5.1.4 Preventing mutual interference between adjacent devices

If a receiver is located in the beam path of an adjacent transmitter, optical crosstalk, and thus erroneous switching and failure of the protective function, may result.

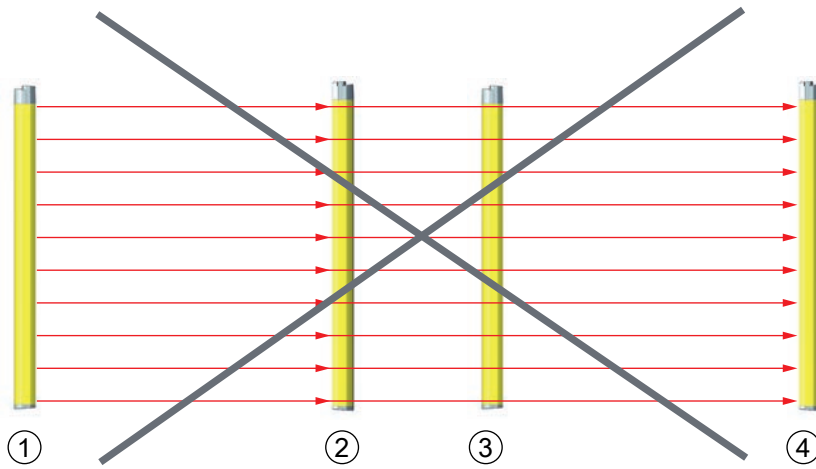

- 1 Transmitter 1
- 2 Receiver 1
- 3 Transmitter 2
- 4 Receiver 2

Fig. 5.4: Optical crosstalk between adjacent safety sensors (transmitter 1 influences receiver 2) due to incorrect mounting

<b>CAUTION</b>
<div style="display: flex; align-items: flex-start;"> <div style="margin-right: 10px;"> </div> <div> <p><b>Possible ineffectiveness of the protective function as a result of systems being installed closely to each other.</b></p> <p>The transmitter of one system can influence the receiver of the other system. This can impair the protective function.</p> <p>↳ Prevent optical crosstalk between adjacent devices.</p> </div> </div>

↳ Mount adjacent devices with a shield between them or install a dividing wall to prevent mutual interference.

↳ Mount the adjacent devices opposite from one another to prevent mutual interference.

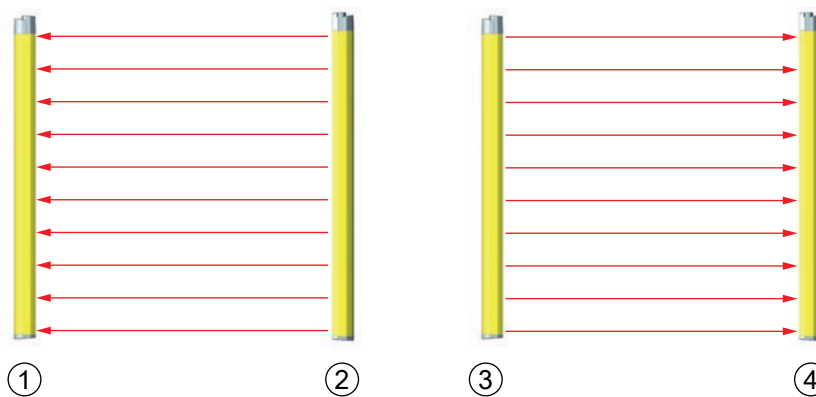

- 1 Receiver 1
- 2 Transmitter 1
- 3 Transmitter 2
- 4 Receiver 2

Fig. 5.5: Opposite mounting

## 5.2 Mounting the safety sensor

Proceed as follows:

- Select the type of fastening, e.g. sliding blocks (see chapter 5.2.2 "Fastening via sliding blocks").
- Have a suitable tool at hand and mount the safety sensor in accordance with the notices regarding the mounting locations (see chapter 5.2.1 "Suitable mounting locations").
- If possible, affix safety notice stickers on the mounted safety sensor or device column (included in delivery contents).

After mounting, you can electrically connect (see chapter 6 "Electrical connection"), start up, align (see chapter 7 "Starting up the device"), and test (see chapter 8.1 "Before commissioning and following modifications") the safety sensor.

### 5.2.1 Suitable mounting locations

Area of application: Mounting

Tester: Technician who mounts the safety sensor

Tab. 5.3: Checklist for mounting preparations

Check:	Yes	No
Do the protective field height and dimensions satisfy the requirements of ISO/EN ISO 13855?		
Is the safety distance to the point of operation maintained (see chapter 5.1.1 "Calculation of safety distance S")?		
Is the minimum distance to reflective surfaces maintained (see chapter 5.1.3 "Minimum distance to reflective surfaces")?		
Is it impossible for safety sensors that are mounted next to one another to mutually interfere with one another (see chapter 5.1.4 "Preventing mutual interference between adjacent devices")?		
Can the point of operation or the danger zone only be accessed through the protective field?		
Has bypassing the protective field by crawling under, reaching over, or jumping over been prevented or has corresponding additional distance $C_{RO}$ in accordance with ISO/EN ISO 13855 been observed?		
Is stepping behind the protective device prevented or is mechanical protection available?		
Do the transmitter and receiver connections point in the same direction?		
Can the transmitter and receiver be fastened in such a way that they cannot be moved and turned?		
Is the safety sensor accessible for testing and replacing?		
Is it impossible to actuate the reset button from within the danger zone?		
Can the entire danger zone be seen from the installation site of the reset button?		
Can reflection caused by the installation site be ruled out?		

#### NOTICE



If you answer one of the items on the checklist above with **no**, the mounting location must be changed.

### 5.2.2 Fastening via sliding blocks

By default, transmitter and receiver are delivered with 2 sliding blocks each in the side slot. This makes fastening the safety sensor to the machine or system to be safeguarded easy via four M5 screws. Sliding in the direction of slot to set the height is possible, but turning, tilting and pitching is not.



Fig. 5.6: Mounting via sliding blocks

### 5.2.3 Fastening via BT-2SB05 swiveling mounting brackets

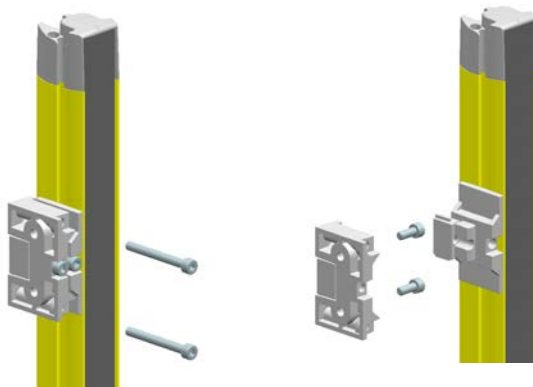





Fig. 5.7: Mounting via swiveling mounting brackets BT-2SB05 and M5 screws

For increased mechanical requirements, these are also available as vibration-damped version (BT-SB05-S). Depending on the installation situation, environmental conditions and protective field length (> 1200 mm), other mounting brackets may also be necessary.

## 6 Electrical connection

 <b>WARNING</b>	
	<p><b>Faulty electrical connection or improper function selection may result in serious injury!</b></p> <ul style="list-style-type: none"> <li>↪ Only allow qualified persons (Necessary competencies) to perform the electrical connection.</li> <li>↪ Make certain that the safety sensor is protected against overcurrent.</li> <li>↪ For access guarding, activate the start/restart interlock and make certain that it cannot be unlocked from within the danger zone.</li> <li>↪ Select the functions so that the safety sensor can be used as intended (see chapter 2.1 "Intended use and foreseeable misuse").</li> <li>↪ Select the safety-relevant functions for the safety sensor (see chapter 3.1 "Structure and function").</li> <li>↪ Always loop both safety-related switching outputs OSSD1 and OSSD2 into the work circuit of the machine.</li> <li>↪ Signal outputs must not be used for switching safety-relevant signals.</li> </ul>
<b>NOTICE</b>	
	<p><b>SELV/PELV!</b></p> <ul style="list-style-type: none"> <li>↪ Acc. to IEC/EN 60204-1, the external power supply must demonstrate the ability to bridge short-term mains failures of up to 20 ms. The power supply unit must ensure safe mains separation (SELV/PELV) and a current reserve of at least 2 A.</li> </ul>
<b>NOTICE</b>	
	<p><b>Laying cables!</b></p> <ul style="list-style-type: none"> <li>↪ Lay all connection cables and signal lines within the electrical installation space or permanently in cable ducts.</li> <li>↪ Lay the cables and lines so that they are protected against external damages.</li> <li>↪ For further information: see ISO/EN ISO 13849-2, Table D.4.</li> </ul>

## 6.1 Pin assignment transmitter and receiver

### 6.1.1 ELC 100 transmitter

ELC 100 transmitters are equipped with a 5-pin M12 connector.

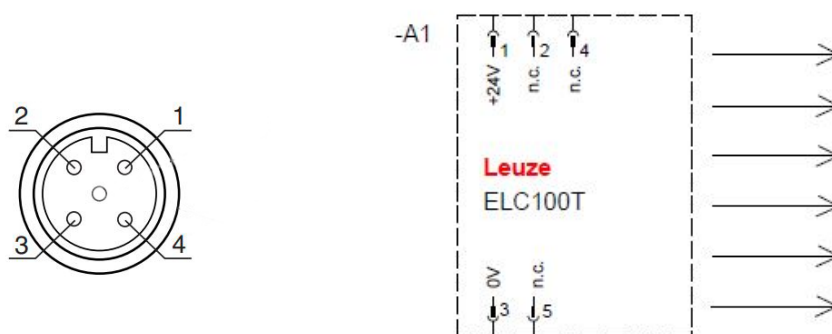

Fig. 6.1: Pin assignment and connection diagram transmitter

Tab. 6.1: Pin assignment of ELC 100 receiver connection cable

Pin	Core color (KD U-M12-4A-P1-xxxx)	Transmitter
1	Brown	24 V
2	White	n. c.
3	Blue	0 V
4	Black	n. c.

### 6.1.2 ELC 110 receiver

ELC 110 receivers are equipped with a 5-pin M12 connector.

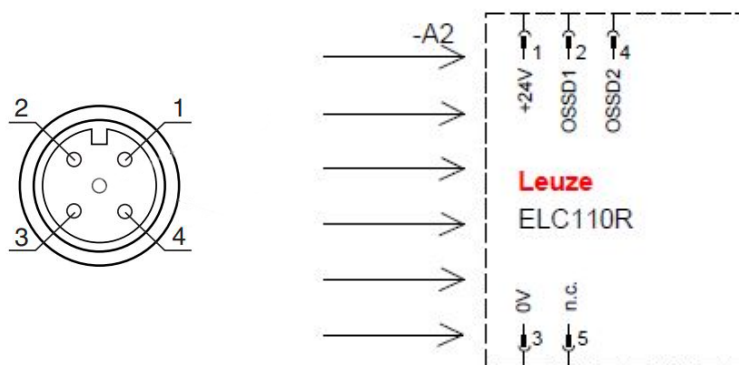



Fig. 6.2: Pin assignment and connection diagram receiver

Tab. 6.2: Pin assignment of receiver connection cable

Pin	Core color (KD U-M12-4A-P1-xxxx)	Receiver
1	Brown	24 V
2	White	OSSD1 - safety-related switching output
3	Blue	0 V
4	Black	OSSD2 - safety-related switching output



## 7 Starting up the device

 <b>WARNING</b>	
	<p><b>Improper use of the safety sensor may result in serious injury!</b></p> <ul style="list-style-type: none"> <li>↪ Make certain that the entire device and the integration of the optoelectronic protective device were inspected by qualified and instructed persons (Necessary competencies).</li> <li>↪ Make certain that a dangerous process can only be started while the safety sensor is switched on.</li> </ul>

Prerequisites:

- Safety sensor mounted (see chapter 5 "Mounting") and connected (see chapter 6 "Electrical connection") correctly
- Operating personnel were instructed in proper use
- Dangerous process is switched off, outputs of the safety sensor are disconnected, and the system is protected against being switched back on
- ↪ After start-up, check the function of the safety sensor (see chapter 8.1 "Before commissioning and following modifications").

### 7.1 Switching on



Requirements for the supply voltage (power supply unit):

- Safe mains separation is ensured.
- Current reserve of at least 2 A is available.
- ↪ Switch on the safety sensor.
- ⇒ The safety sensor performs a self test.

#### Check operational readiness of sensor

- ↪ Check whether LED 1 or LED 2 is permanently lit green or red (see chapter 3.3.2 "Operating indicators on the ELC 110 receiver").
- ⇒ The safety sensor is ready for use.

## 7.2 Aligning the sensor

 <b>CAUTION</b>	
	<p><b>Loss of the safety function due to faulty or incorrect alignment.</b></p> <p>Faulty or incorrect alignment can result in failure of the protective function.</p> <ul style="list-style-type: none"> <li>↪ The alignment performed during start-up should only be performed by qualified persons (Necessary competencies).</li> <li>↪ Observe the data sheets and mounting instructions of the individual components.</li> </ul>

### Prealignment

Fasten the transmitter and receiver in a vertical or horizontal position and at the same height so that

- the front screens are directed at each other.
- the transmitter and receiver connections point in the same direction.
- the transmitter and receiver are arranged parallel to each other, i.e. they are the same distance from each other at the beginning and end of the device.

Alignment can be performed with a clear protective field by observing the LEDs (see chapter 3.3 "Display elements").

↪ Loosen the screws on the mounting brackets or device columns.

<b>NOTICE</b>	
	<p>↪ Loosen the screws only enough so that the devices can just be moved.</p>

↪ Roughly align the transmitter with the receiver.

The receiver of the ELC is equipped with alignment LEDs that detect the optimum state (see chapter 3.3 "Display elements"). The maximum signal level is determined by comparing weaker and stronger levels. The optimum state can thereby be detected for each distance.

↪ Before starting the alignment process, briefly disconnect the receiver from the power supply.



↪ Turn the receiver from left to right until all 4 pairs of the blue alignment LEDs illuminate permanently. As soon as this optimum point is exceeded, the blue LEDs switch off or flash one after the other.

↪ Tighten the fastening screws of the receiver.

↪ Briefly disconnect the receiver from the power supply.

↪ Now align the transmitter according to the same method, paying attention to the display elements of the receiver while doing so (see chapter 3.3.2 "Operating indicators on the ELC 110 receiver").

## 8 Testing

 <b>CAUTION</b>	
	<p><b>It may be the case that safety parameters are no longer met after the mission time.</b></p> <p>The safety parameters can no longer be guaranteed for sensors that are used beyond the mission time.</p> <ul style="list-style-type: none"> <li>↪ Safety sensors must be replaced at the end of their mission time (see chapter 12 "Technical data").</li> <li>↪ Always exchange entire safety sensors.</li> <li>↪ Observe any nationally applicable regulations regarding the tests.</li> <li>↪ Document all tests in a comprehensible manner and include the configuration of the safety sensor along with the data for the safety- and minimum distances in the documentation.</li> </ul>

### 8.1 Before commissioning and following modifications

 <b>WARNING</b>	
	<p><b>Unpredictable machine behavior during start-up may result in serious injury!</b></p> <ul style="list-style-type: none"> <li>↪ Make certain that there are no people in the danger zone.</li> </ul>

↪ Before they begin work, train the operators on their respective tasks. The training is the responsibility of the operating company.

↪ Attach notes regarding daily testing in the respective national language of the operator on the machine in a highly visible location, e.g. by printing out the corresponding chapter (see chapter 8.3 "Periodically by the operator").

↪ Test the electrical function and installation according to this document.

Acc. to IEC/EN IEC 62046 and national regulations (e.g. EU directive 2009/104/EC), tests are to be performed by competent persons (Necessary competencies) in the following situations:

- Prior to commissioning
- Following modifications to the machine
- After longer machine downtime
- Following retrofitting or new configuration of the machine

↪ As preparation, check the most important criteria for the safety sensor according to the following checklist (see chapter 8.1.1 "Checklist for integrator – to be performed prior to commissioning and following modifications"). Completing the checklist does not replace testing by competent persons (Necessary competencies)!

⇒ Not until proper function of the safety sensor is ascertained may it be integrated in the control circuit of the system.

#### 8.1.1 Checklist for integrator – to be performed prior to commissioning and following modifications

<b>NOTICE</b>	
	<p><b>Completing the checklist does not replace testing by a qualified person (Necessary competencies)!</b></p> <ul style="list-style-type: none"> <li>↪ If you answer one of the items on the following check list with <b>no</b>, the machine must no longer be operated.</li> <li>↪ IEC/EN IEC 62046 contains additional recommendations on testing protective devices.</li> </ul>

Tab. 8.1: Checklist for integrator – to be performed prior to the initial start-up and following modifications

Check:	Yes	No	not applicable
Is the safety sensor operated acc. to the specific environmental conditions that are to be maintained (see chapter 12 "Technical data")?			
Is the safety sensor correctly aligned and are all fastening screws and connectors secure?			
Are safety sensor, connection cables, connectors, protection caps and command devices undamaged and without any sign of manipulation?			
Does the safety sensor satisfy the required safety level (PL, SIL, category)?			
Are both safety-related switching outputs (OSSDs) integrated in the downstream machine control acc. to the required safety category?			
Are switching elements that are controlled by the safety sensor monitored according to the required safety level (PL, SIL, category) (e.g., contactors through EDM)?			
Are all points of operation near the safety sensor accessible only through the protective field of the safety sensor?			
Are the necessary additional protective devices in the immediate surroundings (e.g., safety guard) properly mounted and secured against tampering?			
If it is possible to be present undetected between the safety sensor and point of operation: is an assigned start/restart interlock functional?			
Is the command device for unlocking the start/restart interlock mounted in such a way that it cannot be reached from within the danger zone and so that the complete danger zone can be seen from the installation location?			
Has the maximum stopping time of the machine been measured and documented?			
Is the required safety distance maintained?			
Does interruption with a test object intended for this purpose cause the dangerous movement(s) to stop?			
Is the safety sensor effective during the entire dangerous movement(s)?			
Is the safety sensor effective in all relevant operating modes of the machine?			
Is start-up of dangerous movements reliably prevented if an active light beam or the protective field is interrupted with a test object intended for this purpose?			
Was the sensor detection capacity successfully tested (see chapter 8.3.1 "Checklist – periodically by the operator")?			
Were distances to reflective surfaces taken into account during configuration and no reflection bypasses subsequently detected?			
Are notices for regular testing of the safety sensor legible to the operator and are they located in a highly visible location?			
Are settings that could result in an unsafe state possible only by means of key, password or tool?			
Are there incentives that pose stimulus for tampering?			
Were the operators instructed prior to starting work?			

## 8.2 To be performed periodically by competent persons

The reliable interaction of safety sensor and machine must be regularly tested by qualified persons (Necessary competencies) in order to detect changes to the machine or impermissible tampering with the safety sensor.

Acc. to IEC/EN IEC 62046 and national regulations (e.g., EU directive 2009/104/EC), tests of elements which are subject to wear must be performed by qualified persons (Necessary competencies) at regular intervals. Testing intervals may be regulated by nationally applicable regulations (recommendation acc. to IEC/EN IEC 62046: 6 months).



- ↪ Only allow testing to be performed by qualified persons (Necessary competencies).
- ↪ Observe the nationally applicable regulations and the time periods specified therein.
- ↪ As preparation, observe the checklist (see chapter 8.1 "Before commissioning and following modifications").

## 8.3 Periodically by the operator

The function of the safety sensor must be checked depending on the given risk according to the following checklist so that damages or prohibited tampering can be detected.

Depending on the risk assessment, the test cycle must be defined by the integrator or operating company (e.g., daily, on shift changes, ...) or is specified by national regulations or regulations of the employer's liability insurance association and may be dependent on the machine type.

Due to complex machines and processes, it may be necessary under certain circumstances to check some points at longer time intervals. Observe the classification in "Test at least" and "Test when possible".

 <b>WARNING</b>	
	<p><b>Unpredictable machine behavior during the test may result in serious injury!</b></p> <ul style="list-style-type: none"> <li>↪ Make certain that there are no people in the danger zone.</li> <li>↪ Before they begin work, train the operators on their respective tasks and provide suitable test objects and an appropriate test instruction.</li> </ul>

8.3.1 Checklist – periodically by the operator

<b>NOTICE</b>	
	<p>↪ If you answer one of the items on the following check list with <b>no</b>, the machine must no longer be operated.</p>

Tab. 8.2: Checklist – regular function test by trained operators/persons

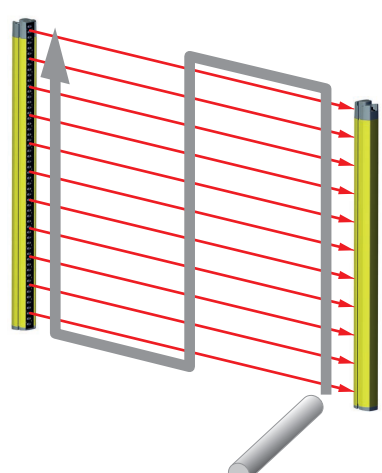
Test at least:	Yes	No
Are safety sensor and connectors securely mounted and free of obvious signs of damage, changes or tampering?		
Were no obvious changes made to access or entry possibilities?		
<p>Test the effectiveness of the safety sensor:</p> <ul style="list-style-type: none"> <li>• The LED 1 on the safety sensor must illuminate green (see chapter 3.3.2 "Operating indicators on the ELC 110 receiver")</li> <li>• Interrupt an active beam or the protective field (see figure) with a suitable, opaque test object:</li> </ul> <div style="text-align: center;">  </div> <p>Checking the protective field function with Leuze test rod</p> <ul style="list-style-type: none"> <li>• Does the OSSD LED on the receiver illuminate constantly red while the protective field is interrupted?</li> </ul>		
When possible, test during running operation:	Yes	No
Protective device with approach function: during machine operation, the protective field is interrupted with the test object – are the obviously dangerous machine parts stopped without noticeable delay?		
Protective device with presence detection: the protective field is interrupted with the test object – does this prevent operation of the obviously dangerous machine parts?		

## 9 Care, maintenance and disposal

<b>NOTICE</b>	
	<p><b>Faulty operation if transmitter and receiver are soiled!</b></p> <p>The surfaces of the front screen of transmitters, receivers and, where applicable, deflecting mirror must not be scratched or roughened at the positions where beams enter and exit.</p> <p>↳ Do not use chemical cleaners.</p>

Prerequisites for cleaning:

- The system is safely shut down and protected against restart.
- ↳ Clean the safety sensor periodically depending on the degree of contamination.

<b>NOTICE</b>	
	<p><b>Prevent electrostatic charging of the front screens!</b></p> <p>↳ To clean the front screens of transmitter and receiver, use only damp cloths.</p>

### Disposing

- ↳ For disposal observe the applicable national regulations regarding electronic components.

## 10 Diagnostics and troubleshooting

### 10.1 What to do in case of failure?

After switching the safety sensor on, the display elements (see chapter 3.3 "Display elements") assist in checking the correct functionality and in faultfinding.

In case of error, you can determine the error from the LED displays. With the error message you can determine the cause of the error and initiate measures to rectify it.

<b>NOTICE</b>	
	<p><b>If the safety sensor responds with an error display, you will often be able to eliminate the cause yourself!</b></p> <ul style="list-style-type: none"> <li>↪ Switch off the machine and leave it switched off.</li> <li>↪ Analyze and eliminate the cause of the fault using the following table.</li> <li>↪ If you are unable to rectify the fault, contact the Leuze branch responsible for you or call the Leuze customer service (see chapter 11 "Service and support").</li> </ul>

### 10.2 Operating indicators of the LEDs

Tab. 10.1: LED indicators at the transmitter - causes and measures

LED	State	Cause	Measure
LED 1, red	Flash sequence ON/OFF (250 ms), followed by OFF (750 ms)	Overvoltage or undervoltage	Check the correct voltage supply. Is 24 V present at the transmitter?
	Flashing (10 Hz)	Device error	Replace the transmitter.
LED 2, green	OFF	Transmitter without supply voltage	Check the power supply unit and the electrical connection. Exchange the power supply unit, if applicable.

Tab. 10.2: LED indicators at the receiver - causes and measures

LED	State	Cause	Measure
LED 1, red	ON	OSSD off	Remove the object from the protective field or align the sensor.
	Flashing (0.5 Hz)	OSSD error	Check the electrical connection of the safety outputs.
	Flash sequence ON/OFF (250 ms), followed by OFF (750 ms)	Overvoltage or undervoltage	Check the correct voltage supply. Is 24 V present at the transmitter?
	Flashing (10 Hz)	Device error	Replace the receivers.
LED 3, blue	Short pulses	Light reception is disturbed	Check whether there are ambient light sources in the input area of the receiver.

## 11 Service and support

### Service hotline

You can find the contact information for the hotline in your country on our website [www.leuze.com](http://www.leuze.com) under **Contact & Support**.

### Repair service and returns

Defective devices are repaired in our service centers competently and quickly. We offer you an extensive service packet to keep any system downtimes to a minimum. Our service center requires the following information:

- Your customer number
- Product description or part description
- Serial number and batch number
- Reason for requesting support together with a description

Please register the merchandise concerned. Simply register return of the merchandise on our website [www.leuze.com](http://www.leuze.com) under **Contact & Support > Repair Service & Returns**.

To ensure quick and easy processing of your request, we will send you a returns order with the returns address in digital form.

### What to do should servicing be required?

<b>NOTICE</b>	
	<p><b>Please use this chapter as a master copy should servicing be required!</b></p> <p>↪ Enter the contact information and fax this form together with your service order to the fax number given below.</p>

### Customer data (please complete)

Device type:	
Serial number:	
Firmware:	
Status of LEDs:	
Error description:	
Company:	
Contact person/department:	
Phone (direct dial):	
Fax:	
Street/No:	
ZIP code/City:	
Country:	

### Leuze Service fax number:

+49 7021 573 - 199

## 12 Technical data

### 12.1 General specifications

Tab. 12.1: Protective field data

Physical resolution [mm]	Operating range [m]		Protective field height [mm]	
	min.	max.	min.	max.
17	0.5	3	300	1500
30	0.5	6	300	1500

Tab. 12.2: Safety-relevant technical data

Type in accordance with IEC/EN IEC 61496	Type 4
SIL in accordance with IEC/EN 61508	SIL 3
SILCL in accordance with IEC/EN 62061	SIL 3
Performance Level (PL) in accordance with ISO/EN ISO 13849-1:2015	PL e
Category in acc. with ISO/EN ISO 13849-1:2015	Cat. 4
Average probability of a failure to danger per hour (PFH <sub>d</sub> )	8 x 10 <sup>-9</sup> 1/h
Mission time (T <sub>M</sub> )	20 years

Tab. 12.3: General system data

Connection technology	M12, 4-pin
Supply voltage U <sub>v</sub> , transmitter and receiver	+24 V, ± 20 %, compensation necessary at 20 ms voltage dip, min. 250 mA (+ OSSD load)
Residual ripple of the supply voltage	± 5 % within the limits of U <sub>v</sub>
Current consumption - transmitter	40 mA
Current consumption receiver	100 mA (without load)
Common value for ext. fuse in the supply line for transmitter and receiver	2 A semi time-lag
CULus range of validity	Connection with cables acc. to the listed R/C (CYJV2/7 or CYJV/7) cables or cables with corresponding data.
Synchronization	Optical between transmitter and receiver
Protection class	III
Degree of protection	IP65
Ambient temperature, operation	0 ... 50 °C
Ambient temperature, storage	-30 ... 70 °C
Relative humidity (non-condensing)	0 ... 95 %
Vibration/shock resistance	Class 3M4 (IEC TR 60721-4-3)
Vibration resistance	5 Hz ... 150 Hz; 3.5 mm/1g (IEC 60068-2-6)
Shock resistance	15 g, 6 ms (IEC 60068-2-27)  In addition to the tests in accordance with IEC 60068-2-27, the safety light curtain was subject to additional continuous shock tests. The devices withstood 100000 shocks of 40 g on each spatial axis without change.
Profile cross section	29 mm x 35.4 mm

Dimensions	see chapter 12.2 "Dimensions, weight, response time"
Weights	see chapter 12.2 "Dimensions, weight, response time"

Tab. 12.4: System data - transmitter

Light source	LED; exempt group in acc. with IEC/EN 62471
Wavelength	940 nm
Pulse duration	1.6 $\mu$ s
Pulse pause	3.5 $\mu$ s (min.)
Mean power	<50 $\mu$ W

**NOTICE**



The UL testing only includes fire and shock tests.

Tab. 12.5: Technical data of the electronic safety-related switching outputs (OSSDs) on the receiver

Safety-related PNP transistor outputs (short-circuit monitored, cross-circuit monitored)	Minimum	Typical	Maximum
Switching voltage high active ( $U_v - 1.5V$ )	18 V	22.5 V	27 V
Switching voltage low		0 V	+2.0 V
Switching current			50 mA
Residual current			500 $\mu$ A In the event of a failure (if the 0 V cable is interrupted), each of the outputs behaves as a 120 k $\Omega$ resistor to $U_v$ . A downstream safety PLC must not detect this as a logical "1".
Load capacity			30 nF
Load inductivity			500 mH
Permissible wire resistance for load			< 20 $\Omega$ Note the additional restrictions due to cable length and load current.
Permissible wire cross section	0.25 mm <sup>2</sup>	0.34 mm <sup>2</sup>	
Permissible cable length between receiver and load			15 m
Test pulse width (1*)		200 $\mu$ s	
Test pulse spacing (1*)		20 ms	
OSSD restart delay time after beam interruption		100 ms	

(1\*) The outputs are tested cyclically (brief low or high switching). When selecting the downstream control elements, make sure that with the parameters specified above, the test pulses do not lead to a shutdown.

**NOTICE**

The safety-related transistor outputs perform the spark extinction. With transistor outputs, it is therefore neither necessary nor permitted to use the spark extinction circuits recommended by contactor or valve manufacturers (RC elements, varistors or recovery diodes), since these considerably extend the decay times of inductive switching elements.

## 12.2 Dimensions, weight, response time

Dimensions, weight and response time are dependent on

- the resolution
- the length

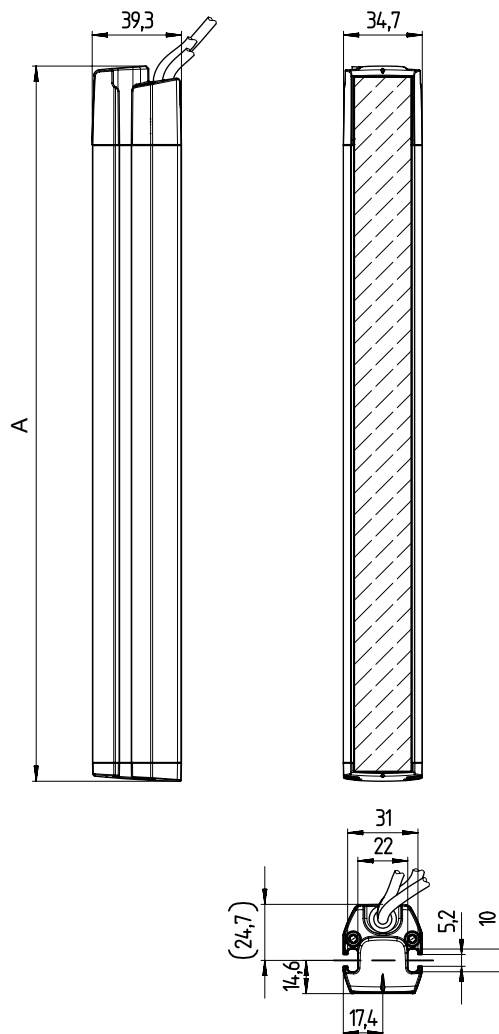

Fig. 12.1: Dimensions of transmitter and receiver

Tab. 12.6: Dimensions, weights and response times of transmitter and receiver

Device type	Transmitter and receiver		Transmitter	Receiver	Receiver	
Type	Dimension [mm]		Weight [kg]		Response time [ms]	
	PF (protective field length)	A (total length)			17 mm	30 mm
ELC...-300	300	315	0.51	0.53	5.6	4.7
ELC...-600	600	615	0.91	0.93	9.5	5.6
ELC...-900	900	915	1.31	1.33	13.4	7.5
ELC...-1200	1200	1215	1.71	1.73	17.3	9.5
ELC...-1500	1500	1515	2.11	2.12	21.2	11.4

12.3 Dimensioned drawings: Accessories

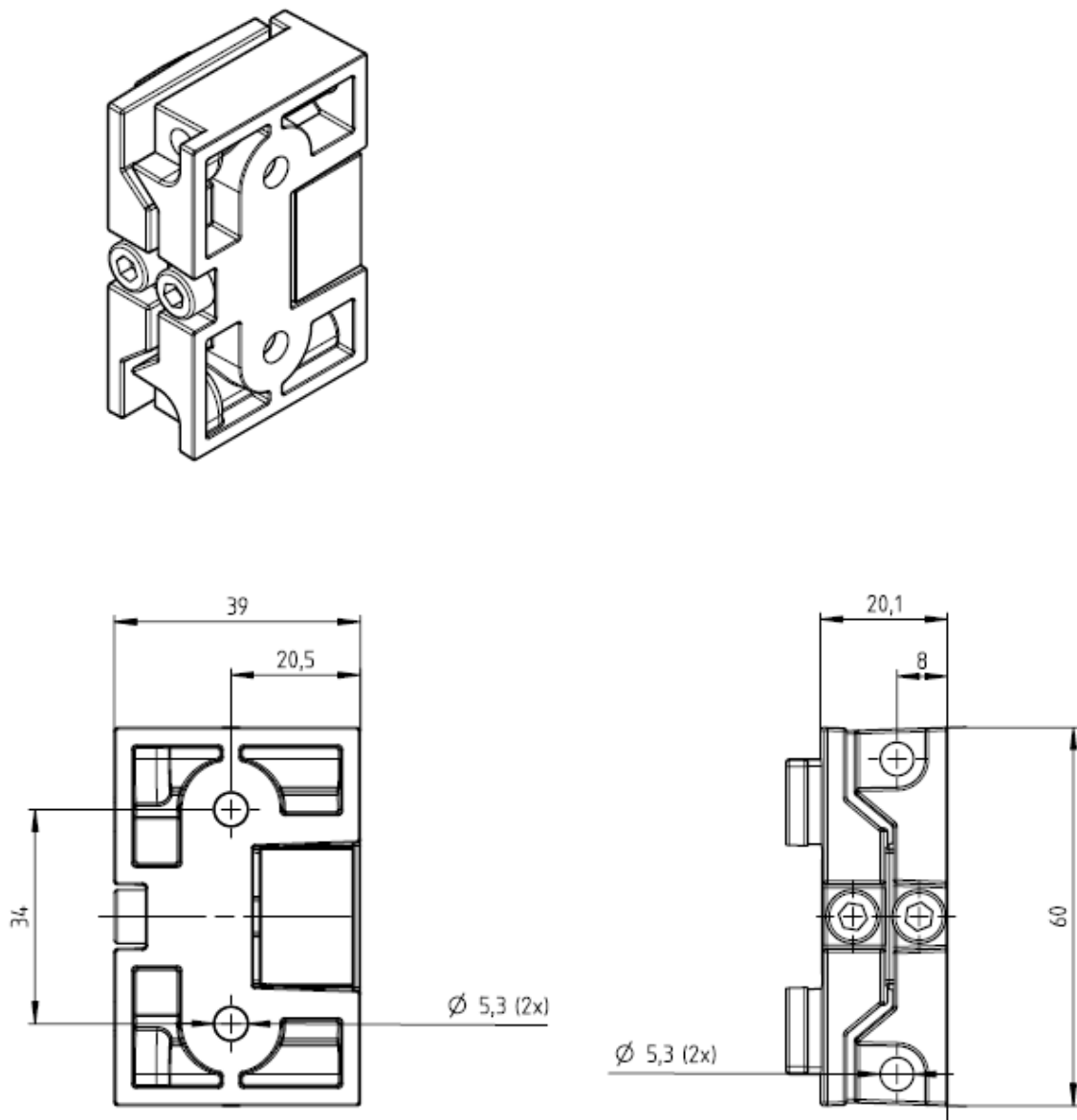

Fig. 12.2: Swiveling mounting bracket for groove mounting BT-SB05

## 13 Order guide and accessories

### 13.1 Part number code

#### ELC1yyzaa-hhhh

ELC	Operating principle: safety light curtain
1	Series: ELC 100
yy	Function class: 00: transmitter 10: receiver – automatic restart
z	Device type: T: transmitter R: receiver
aa	Resolution: 17: 17 mm 30: 30 mm
hhhh	Protective field height: 300: 300 mm 600: 600 mm 900: 900 mm 1200: 1200 mm 1500: 1500 mm

Tab. 13.1: Part descriptions, examples

Part designation	Properties
ELC100T17-600	Type 4 transmitter, PL e, SIL 3, resolution 17 mm, protective field height 600 mm
ELC100T30-900	Type 4 transmitter, PL e, SIL 3, resolution 30 mm, protective field height 900 mm
ELC110R30-1500	Type 4 receiver, PL e, SIL 3, resolution 30 mm, protective field height 1500 mm

#### Scope of delivery

- Transmitter including 2 sliding blocks, 1 instruction sheet
- Receiver including 2 sliding blocks, 1 self-adhesive notice sign "Important notices and notices for the machine operator", set of user notes

### 13.2 Type overview

Tab. 13.2: ELC 100 transmitter

Type designation	Part no.	Protective field height [mm]	Resolution [mm]
ELC100T17-300	72000103	300	17
ELC100T17-600	72000106	600	17
ELC100T17-900	72000109	900	17
ELC100T17-1200	72000112	1200	17
ELC100T17-1500	72000115	1500	17
ELC100T30-300	72000303	300	30

Type designation	Part no.	Protective field height [mm]	Resolution [mm]
ELC100T30-600	72000306	600	30
ELC100T30-900	72000309	900	30
ELC100T30-1200	72000312	1200	30
ELC100T30-1500	72000315	1500	30

Tab. 13.3: ELC 110 receiver

Type designation	Part no.	Protective field height [mm]	Resolution [mm]
ELC110R17-300	72001103	300	17
ELC110R17-600	72001106	600	17
ELC110R17-900	72001109	900	17
ELC110R17-1200	72001112	1200	17
ELC110R17-1500	72001115	1500	17
ELC110R30-300	72001303	300	30
ELC110R30-600	72001306	600	30
ELC110R30-900	72001309	900	30
ELC110R30-1200	72001312	1200	30
ELC110R30-1500	72001315	1500	30

### 13.3 Accessories

Tab. 13.4: Accessories

Part no.	Article	Description
<b>Connection cables for transmitter and receiver, unshielded</b>		
50130654	KD U-M12-4A-P1-020	Connection cable, 4-pin, 2 m long
50130656	KD U-M12-4A-P1-030	Connection cable, 4-pin, 3 m long
50130657	KD U-M12-4A-P1-050	Connection cable, 4-pin, 5 m long
50130658	KD U-M12-4A-P1-100	Connection cable, 4-pin, 10 m long
<b>Mounting technology</b>		
424428	BT-SB05	Swiveling mounting bracket for groove mounting, $\pm 8^\circ$ , 1x
424432	BT-2SB05	Swiveling mounting bracket for groove mounting, $\pm 8^\circ$ , 2x
424433	BT-2SB05-S	Swiveling mounting bracket for groove mounting, $\pm 8^\circ$ , vibration damped, 2x
<b>Test rods</b>		
430417	AC-TR-17-S	Test rod length 240 mm, diameter 17 mm
430434	AC-TR-30-S	Test rod length 240 mm, diameter 30 mm

## **14 EC Declaration of Conformity**

The safety light curtains of the ELC 100 series have been developed and manufactured in accordance with the applicable European standards and directives.